

# SPECIFICATION

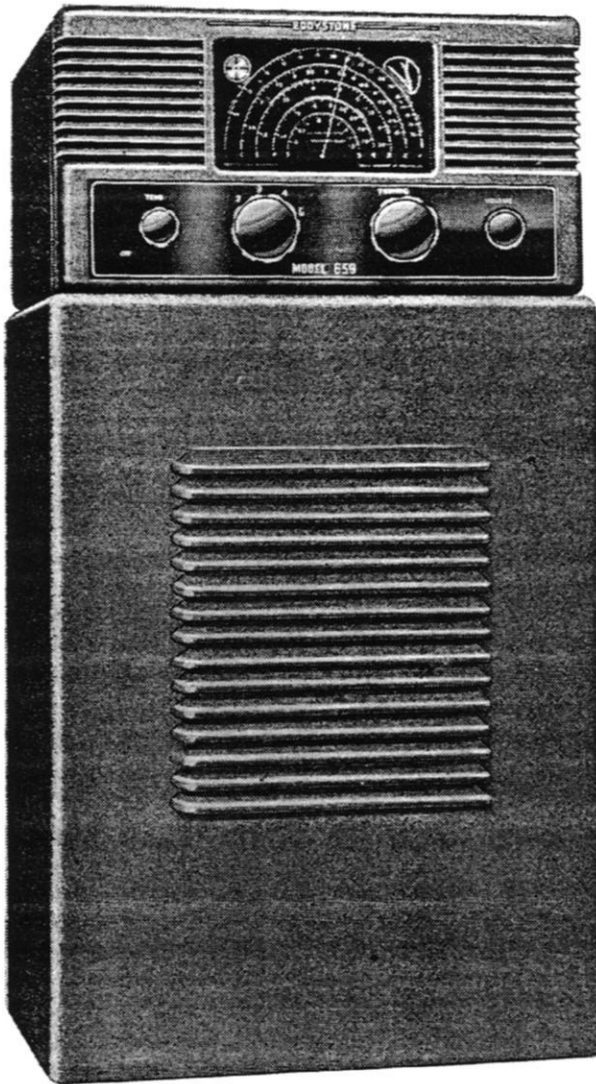

EDDYSTONE RECEIVER TYPE 659.

## GENERAL.

The "659" Receiver has been specially developed for overseas use and will give consistently good reception of both short and medium wave broadcast stations in any part of the world, and under any climatic conditions. Many refinements are included in the design, which has received careful attention to ensure that the performance shall be of a high standard in all respects.

The following are outstanding features of the Receiver :—

- Excellent Sensitivity.
- Good Selectivity.
- Good Frequency Stability.
- Accurate Calibration.
- Flywheel controlled Tuning Mechanism.
- Edge Illuminated Dial.
- Robust Construction.

Two models are manufactured. One, designated "659/AC," operates from A.C. mains, 40/60 cycles, 200/240 or 110 volts, the consumption being about 45 watts. The other model—the "659/B"—has a vibrator power unit, the consumption being 5.9 amps. from a 6 volt accumulator.

## FREQUENCY COVERAGE.

Four switched ranges cover all the principal short and medium wave broadcast bands. The exact coverage is :—

- |         |  |
|---------|--|
| Band 1. | 30 to 12.8 Mc/s. (10 to 23.5 metres).  |
| Band 2. | 13 to 5.8 Mc/s. (23.1 to 51.7 metres). |
| Band 3. | 2.75 to 1.2 Mc/s. (110 to 250 metres). |
| Band 4. | 248 to 575 Metres (1220 to 522 Kc/s.). |

There is an overlap between Bands 1 and 2, and between Bands 3 and 4. The first three ranges are calibrated in frequency and the fourth in wavelength, to conform to published details of broadcasting stations. An additional feature, for ease of identification, is the colour marking of the short wave broadcast and amateur bands, and a further indication in metres of each short wave broadcast band.

It is of interest to note that the 28, 14, 7 and 1.7 Mc/s. Amateur Bands are included and also the 150 metre Shipping Band.

## TUNING MECHANISM.

The tuning mechanism has a high reduction ratio and is flywheel controlled, giving smooth, positive operation. A special logging scale is provided at the top right hand corner of the dial, giving an actual scale length of 90 inches. The exact reading of any particular station can be noted, to enable the user to return to it at any time. The Electronic Tuning Indicator ("Magic-Eye") fitted at the top left hand corner assists in tuning in stations accurately.

The dial, which is edge illuminated, is distinctive in appearance and easily readable.

## CIRCUIT (see Fig. 1 at rear of book).

The R.F. Amplifier stage employs a low noise pentode, which, in conjunction with the very efficient coils, gives a high gain.

The frequency changer valve is a triode-hexode. It is followed by an Intermediate Frequency Amplifier, using efficient transformers with permeability tuned coils. The interstage couplings in the R.F. and I.F. sections have been carefully adjusted to secure maximum sensitivity and adequate selectivity.

A double diode-triode valve performs the functions of signal rectifier and first audio amplifier. It also provides A.V.C. voltage which is fed to the three earlier valves, to counteract fading.

The output stage employs a beam power valve capable of delivering up to 3 watts of audio output. Negative feedback is incorporated, giving improved quality of reproduction.

Electrical interference can at times be troublesome on short waves, and a noise limiter has therefore been fitted. It can be brought in and out of circuit, as desired.

A full wave, indirectly heated rectifier, with ample smoothing, ensures good regulation of the power supply with negligible hum.

## VALVE SEQUENCE.

The positions of the valves are shown in Fig. 4, and the types used are as follows :—

V1	R.F. Amp.	EF39	Mullard
V2	Frequency Changer	6K8GT	Brimar
V3	I.F. Amp.	EF39	Mullard
V4	Det. 1st Audio, A.V.C.	EBC33	Mullard
V5	Output Valve	6V6GT	Brimar
V6	Power Rectifier	6X5GT	Brimar
V7	Noise Limiter	EB34	Mullard
V8	Tuning Indicator	EM34	Mullard

## CONSTRUCTION.

The R.F. coils are housed in a diecast box, which is firmly secured to the diecast front panel. These two units form a rigid foundation around which the receiver is built.

All components are tropicalised and ventilation has been carefully arranged to prevent any undue temperature rise.

## INSTALLATION AND OPERATION (659/AC)

The receiver has been aligned, calibrated and thoroughly tested before packing. The mains voltage selector panel at the rear (see Fig. 3) is normally set in the 230 volts position, where it may remain for input voltages between 215 and 240 volts. For mains voltages between 210 and 195, the selector should be inserted in the 200 volt position. A further adjustment is provided for supplies of 110/115 volts.

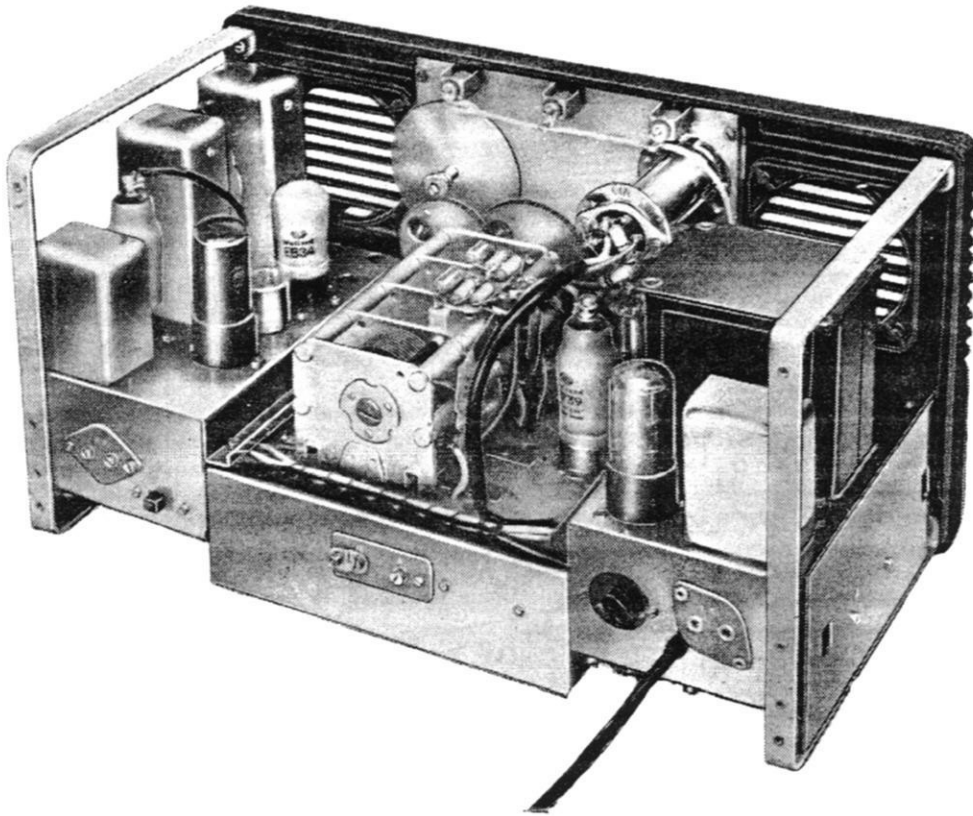

Fig. 2. Plan view of "659" Receiver.

Fig. 3 indicates the appropriate connections to be made to the receiver. For general use, an aerial about 60 feet long should be erected as high as possible and clear of other objects, but good results will be secured on shorter aerials, particularly on the higher frequencies. The lead-in wire should be connected to the rear terminal marked "A," and if possible, a good earth to the terminal marked "AE," the latter remaining strapped to the chassis.

The doublet aerial is preferable when it is desired to secure optimum results on any particular band of frequencies. In this case, the twin feeders, of about 400 ohms impedance, should be connected to the two terminals after removing the strap between "AE" and chassis.

The console speaker is arranged to provide a stand for the receiver.

### CONTROLS.

The controls are clearly indicated and comprise :—

Tuning Knob.

Band Selector Knob.

Volume Control.

Combined Tone Control and On/Off Switch.

The Band Selector switch has five positions, the first four of which are numbered to agree with the numbers against each range on the dial. In the fifth position, marked "G," the radio section of the receiver is rendered inoperative, to avoid breakthrough when using a gramophone pick-up. The latter is connected to the two terminals indicated in Fig. 3, and should, for preference, be of the medium impedance type. The modern lightweight armature pick-up, with, if necessary, a suitable input transformer, will be found to give very satisfactory results.

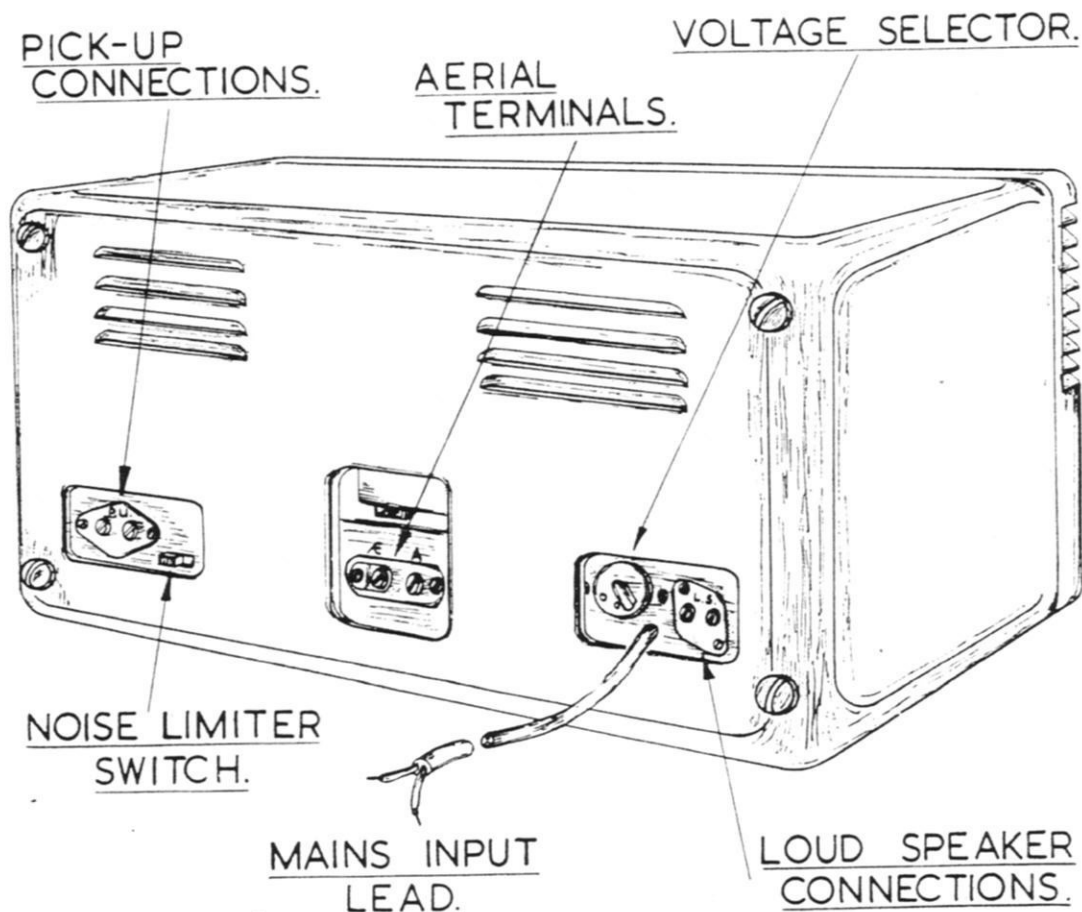

Fig. 3. Rear outline of the " 659 " Receiver with details of external connections.

Tuning is carried out in the normal way, after setting the Band Selector Switch to the appropriate range. Volume and tone are then adjusted to suit individual tastes and circumstances.

#### **NOISE LIMITER.**

When using the short wave ranges — particularly Band I — in some locations trouble may be experienced from noise of a peaky nature, such as is produced by the ignition systems of cars, etc., electrical appliances and so forth.

At the rear of the receiver is a small switch, indicated in Fig. 3. Sliding this along will bring the special noise limiter circuit into action and it will reduce considerably the strength of the interfering noise. It is inevitable that this device, to be effective, should slightly affect the quality of reproduction when switched into circuit (by moving the switch towards the centre of the receiver).

#### **ALIGNMENT INSTRUCTIONS.**

The following instructions are based on the assumption that the receiver has suffered no major misalignment.

Although minor adjustments may be carried out without them, it is definitely much more satisfactory, for proper alignment, to use test instruments, the following being essential :—

1. A Signal Generator, fitted with a calibrated attenuator and having internal modulation. The frequency range should cover that of the receiver and the intermediate frequency. Should the output leads not show D.C. continuity, a 1 megohm resistor should be connected across them. For the sake of brevity the Signal Generator is referred to in the following notes as the Sig. Gen. When aligning the R.F. stages, a dummy aerial, suitable for high frequencies,

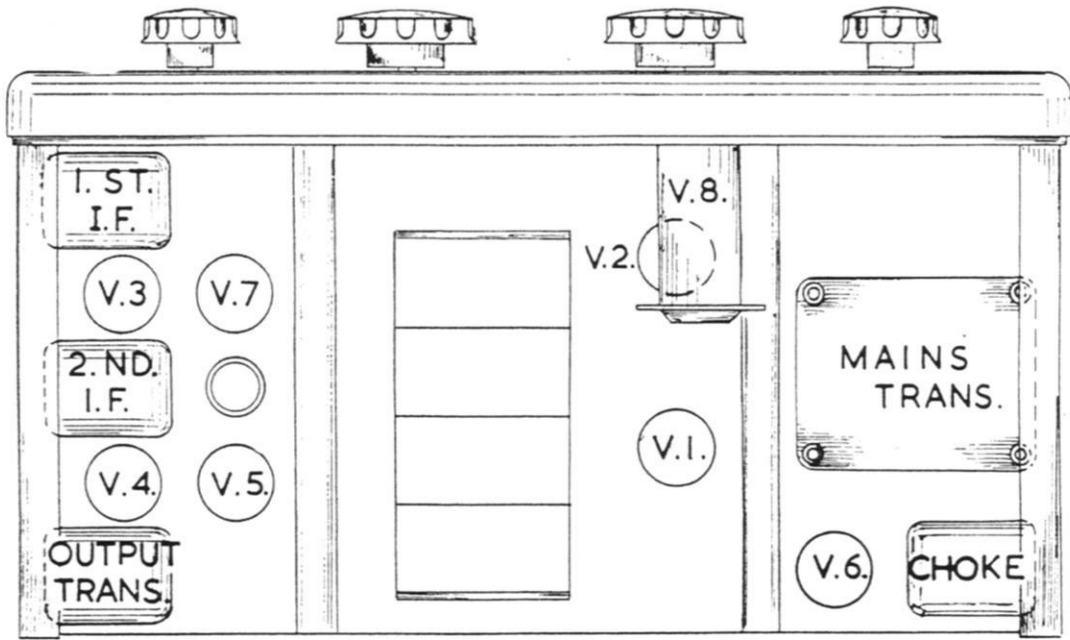

Fig. 4. Plan view in outline.

should be interposed between the direct output of the generator and the aerial terminals of the receiver. Should no dummy aerial be supplied with the generator, a 400 ohm carbon resistor will serve, fitted in series with the high potential lead.

2. An audio output meter, calibrated in milliwatts and decibels, to match an impedance of 2.5 ohms.
3. A non-metallic trimming tool, with a screwdriver shaped end, for adjusting coil cores, etc. The Eddystone Cat. No. 122T tool is suitable.

The receiver should be removed from its cabinet (by unscrewing the four screws at the rear) and stood on its lefthand end, face to the operator. Connect the output meter across the speaker terminals, leaving the speaker connected, as this is helpful.

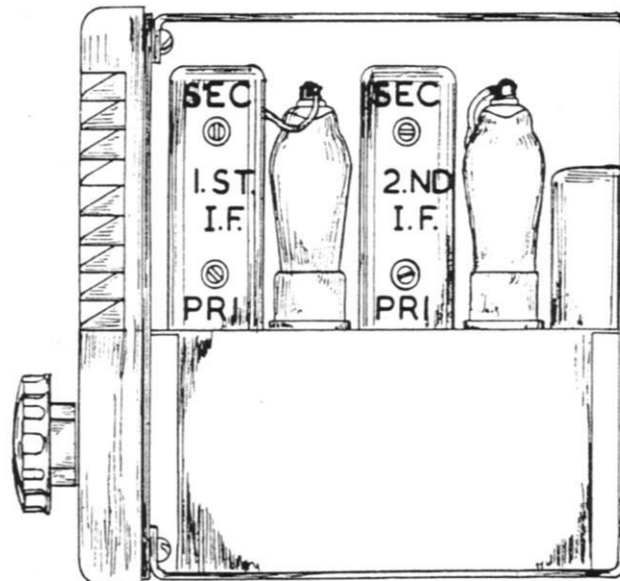

Fig. 5. Location of I.F. Transformer Cores.



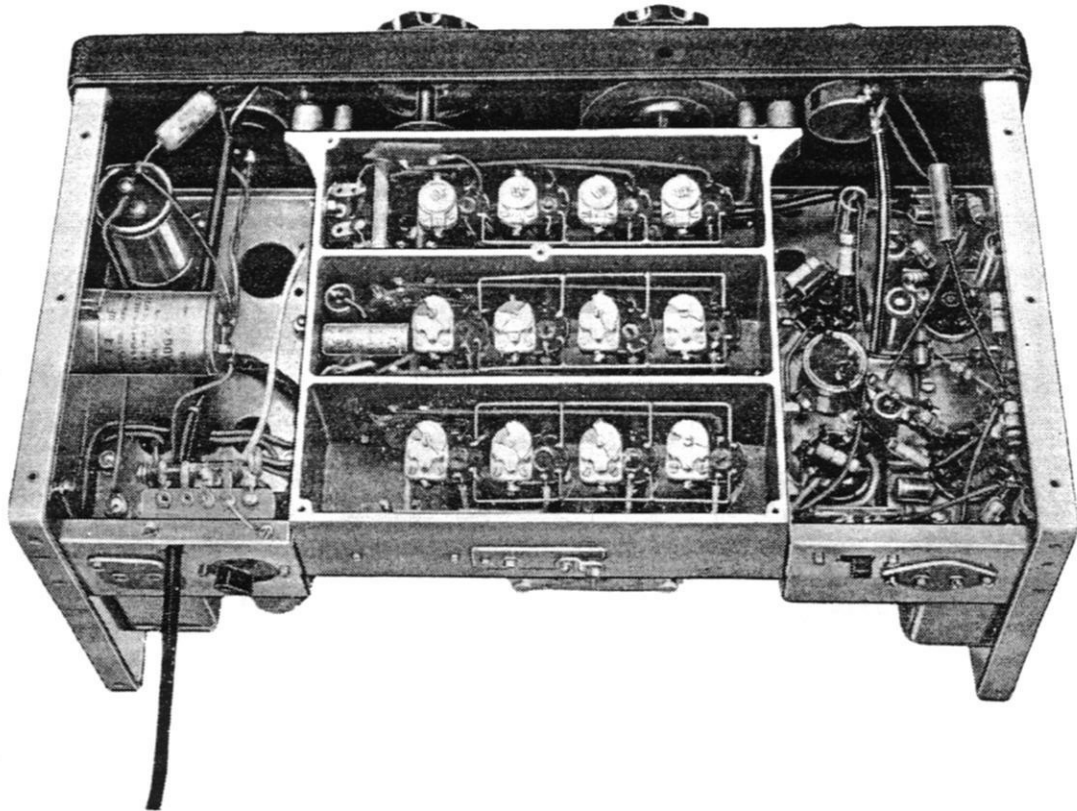

Fig. 6. Underside view of "659" Receiver.

### I.F. CIRCUITS.

The intermediate frequency is 450 Kc/s. The I.F. Transformers are well designed and constructed and are unlikely to drift off frequency over long periods.

Before commencing alignment, allow the receiver and the Sig. Gen. to warm up for at least ten minutes, to minimise frequency drift. Set the Tone and Volume Controls fully clockwise, Band Selector Switch at 13 Mc/s. on Band I, and Noise Limiter Switch off.

Remove the grid clip from the top cap of the 6K8 valve (V2) and connect the Sig. Gen. leads between the valve top cap and chassis. The Sig. Gen. should be adjusted to a frequency of 450 Kc/s., 30% modulated, with the attenuator set to give an output in the region of 100 microvolts.

Then proceed to adjust, with the insulated trimming tool, the cores in the I.F. transformers, commencing with the first primary and working through to the second secondary, the positions of which are shown in Fig. 5. The Sig. Gen. output should be reduced as necessary. When maximum output has been secured the attenuator should indicate between 70 and 80 microvolts for a 50 milliwatt output, as shown on the meter *with the speaker disconnected*. Should the attenuator reading be higher than this, it is possible that the valve emission is beginning to fail.

### R.F. AND OSCILLATOR RE-ALIGNMENT.

For the sake of completeness, the instructions which follow give the whole procedure for re-alignment of the radio frequency, frequency changer and oscillator sections. It is emphasised, however, that usually all that will be necessary is slight adjustment of the trimmer condensers and this operation can be carried out without removing the cover of the coil box. In the first place, therefore, only those instructions in the following paragraphs dealing with trimmer adjustment should be attended to. If the alignment is still not wholly satisfactory, the coil cores may be adjusted but considerable care is called for to ensure that proper tracking is maintained.

coil box. The oscillator trimmers should not be touched unless the calibration is obviously incorrect.

If adjustment of the oscillator frequency is found necessary, a station should be tuned in, the identity and frequency of which is not in doubt, and preferably towards the high frequency end of the particular wave range. The appropriate trimmer condenser, as set out above, should then be adjusted, at the same time slowly rotating the main dial until the pointer coincides with the frequency at which the selected station is known to be operating.

To tune up the other stages, select a broadcasting station which is known to be of consistent strength and not liable to fading, again preferably at the high frequency end of the band. The tuning indicator will be used to give indications of correct adjustment, and to obtain clear indications, it may be advisable to reduce the strength by using temporarily a shorter aerial than is normally employed. The appropriate trimmers are then adjusted. This process is followed on each range, as may be found necessary, the aim being to secure maximum closing up of the shadow in the tuning indicator.

### SERVICING.

When a multi-range meter is available, the accompanying chart of voltage values, used in conjunction with the circuit diagram, will prove an invaluable aid to the quick location of any fault which may arise. When a meter is not to hand, the task of locating a fault may not be easy, but certain symptoms, outlined below, will be of assistance. If the receiver stops working, it is almost certain that replacement of a component or valve will be necessary and the user who is in an isolated area will be well advised to keep some spare parts ready for use if required.

Under working conditions, a red glow can be seen from all the valve heaters, with the exception of the EB34. Complete lack of H.T. voltage will be evidenced by the failure of the tuning indicator (EM34) to give its normal green glow and by complete absence of sound from the loud speaker, although the latter may result from a defective output valve or output transformer.

If the valves appear to be sound and the H.T. voltage normal, as far as can be ascertained, turn the volume control full on and touch the top grid of V4 (there is no danger of shock). A loud howl or hum should result — if not, the trouble lies in the sections of the receiver associated with V4 and the following stage. If the howl does occur, then the trouble lies in an earlier stage. Touch the top caps of the other valves, working backwards from V3. In each case, at least a click should be heard in the speaker and if, on touching one particular top cap, no sound is heard, it is likely that the fault lies in the circuit elements between the silent valve and the next good one. The actual fault may be in the valve, in a resistor or condenser, or possibly (but rarely) in one of the coils.

Should difficulty be experienced in obtaining valves of identical types, when replacement becomes necessary, the following valves may be used in lieu. In some cases — particularly the 6K7 — there may be some falling off in sensitivity — in others, there will be no noticeable difference.

6K7	for EF39
or	
6K7G	
6Q7	for EBC33
6H6	for EB34
6AF7G	for EM34

### CHANGING DIAL LIGHTS.

The holders for the lamps which illuminate the dial are sprung into place. To change a lamp, all that is necessary is to press the holder and pull out. The lamp is of the miniature bayonet fixing type, rated at 6.3 volts 1 watt.

## "659/B" BATTERY RECEIVER

The battery version of the "659" Receiver is identical with the exception of the power unit and all the foregoing remarks about operation, alignment, etc., apply equally to both models.

Instead of the mains plug, a heavy battery cable is provided, approximately 6 feet long, and the correct polarity should be observed. The battery used with the receiver should be of the heavy duty car type, with a capacity of at least 60 ampere hours. It should be in good condition (a high internal resistance will seriously impair performance) and kept well charged. The current consumption, including valve heaters, is 5.9 amperes.

The normal life to be expected from the vibrator unit is about 1000 hours. Signs that the vibrator, which is of the plug-in non-synchronous type, requires replacement, are erratic performance of the receiver and possibly a much increased noise level. Blowing of the fuse may also indicate that the vibrator has reached the end of its useful life.

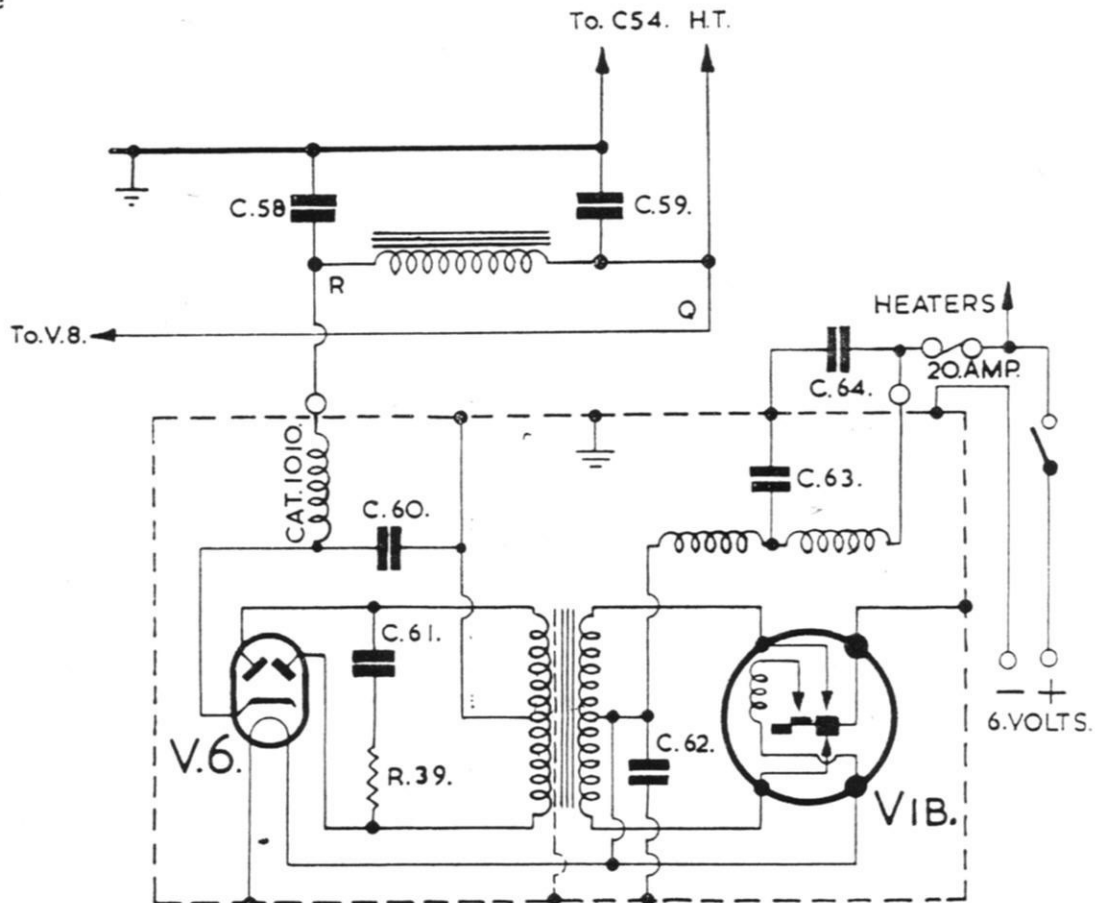

Fig. 8. Circuit of the Battery Power Unit in the "659/B" Receiver.

Fig. 8 gives the circuit diagram of the battery power unit, which fits into the chassis in the position otherwise occupied by the mains power unit. To remove the top part of the unit, containing the transformer vibrator, rectifying valve and sundry filter components, it is only necessary to remove four screws and unsolder the three connections made to the ceramic bushed outlets at the side. The lower part holds the smoothing components, and the whole is easily accessible for servicing purposes. The vibrator unit is held in place with a spring assembly, which must be slipped over to one side before the vibrator can be withdrawn from its socket.

The voltage on each anode of the rectifier valve is 200, the smoothed output from the unit being 190 volts, 50 mA.



Several additional Components, not shown on the general component list, are included in the battery version of the Receiver, and details of these are given herewith.

R39	4700 ohms $\frac{1}{2}$ watt.
C58, 59	8 mfd. Tubular Electrolytic 350/500 volt, (substitution).
C60	.005 mfd. Moulded Mica.
C61	.01 or .012 mfd. Paper, 1000 volt working
C62, 64	.5 mfd. Tubular Paper.
C63	.005 mfd. Moulded Mica.
Vibrator Unit, type NS/6 (Wearite).	

### VOLTAGE VALUES (659/B).

Refer to circuit Figs. 1 and 8. The voltages are between the point indicated and the chassis. Set receiver at 14 Mc/s on Range 1, with the aerial shorted out, volume control at maximum and the tone control fully clockwise. Two sets of values are given using different meters as shown. It will be evident that the actual voltage indicated depends on the particular meter employed. A tolerance of plus or minus 5% should be allowed on the values given.

Circuit Ref.	Weston 1,000 ohms/volt	Avo. Model 40	Circuit Ref.	Weston 1,000 ohms/volt	Avo. Model 40
A	170	160	L	65	45
B	65	55	M	1.7	1.0
C	1.4	1.3	N	180	180
D	180	175	O	190	190
E	60	55	P	8.8	8.3
F	2.1	2.0	Q	190	190
G	65	60	R	200	200
H	165	160	S	25	15
J	65	55	T	25	15
K	1.4	1.3	U	190	190

### VOLTAGE VALUES (659/AC).

Refer to circuit Fig. 1. The voltages are between the point indicated and chassis. Set the receiver at 14 Mc/s on Range 1, with the aerial shorted out, volume control at maximum, and the tone control fully clockwise. Two sets of values are given using different meters as shown. It will be evident that the actual voltage indicated depends on the particular meter employed. A tolerance of plus or minus 5% should be allowed on the figures given.

Circuit Ref.	Weston 1,000 ohms/volt	Avo. Model 40	Circuit Ref.	Weston 1,000 ohms/volt	Avo. Model 40
A	225	215	L	85	60
B	90	70	M	2.7	1.6
C	2.0	1.8	N	245	235
D	240	225	O	250	245
E	100	95	P	12	11.1
F	3.5	3	Q	250	245
G	80	75	R	265	260
H	225	210	S	42	20
J	85	70	T	25	15
K	2.0	1.9	U	250	245

## COMPONENT VALUES.

### RESISTORS.

(All  $\frac{1}{2}$  watt except where otherwise stated).

R1	.47 or .5 megohms.	R21	22 or 25 ohms.
R2	.47 or .5 megohms.	R22	330 or 300 ohms.
R3	.1 megohm.	R23	22,000 or 20,000 ohms.
R4	4,700 or 5,000 ohms.	R24	.1 megohm.
R5	330 or 300 ohms.	R25	.5 megohm. Pot. 3136P.
R6	15,000 ohms. 1 watt.	R26	27,000 or 30,000 ohms.
R7	27,000 or 30,000 ohms. 1 watt.	R27	.27 or .25 megohms.
R8	22,000 or 20,000 ohms. 1 watt.	R28	.27 or .25 megohms.
R9	.47 or .5 megohms.	R29	3,300 or 3,000 ohms.
R10	.47 or .5 megohms.	R30	.47 or .5 megohms.
R11	330 or 300 ohms.	R31	.1 megohm.
R12	4,700 or 5,000 ohms.	R32	270 or 250 ohms. 1 watt.
R13	47,000 or 50,000 ohms.	R33	50,000 ohms. Pot. 3137P. With switch.
R14	12 ohms.	R34	.47 or .5 megohms.
R15	47 or 50 ohms.	R35	.47 or .5 megohms.
R16	560 or 500 ohms.	R36	.47 or .5 megohms.
R17	.47 or .5 megohms.	R37	1.0 megohm.
R18	.1 megohm.	R38	1.0 megohm.
R19	330 or 300 ohms.		
R20	4,700 or 5,000 ohms.		

### CONDENSERS.

C1	3—20 pf.	Air Trimmer.	C30	3000 pf.	Silvered Mica.
C2	10 pf.	Ceramic.	C31	3.5—20 pf.	Ceramic Trimmer.
C3	3—20 pf.	Air Trimmer.	C32	2000 pf.	Silvered Mica.
C4	10 pf.	Ceramic.	C33	640 pf.	Silvered Mica.
C5	3—20 pf.	Air Trimmer.	C34	3.5—20 pf.	Ceramic Trimmer.
C6	3—20 pf.	Air Trimmer.	C35	280 pf.	Silvered Mica.
C7	100 pf.	Silvered Mica.	C36	3.5—20 pf.	Ceramic Trimmer.
C8	11.5—210.6 mmfd.	R.F. Sect. 3 Gang.	C37	100 pf.	Silvered Mica.
C9	.01 mfd.	Tub. Paper.	C38	11.5—210.6 mmfd.	Osc. Sect. 3 Gang.
C10	.1 mfd.	Tub. Paper.	C39	.1 mfd.	Tub. Paper.
C11	.1 mfd.	Tub. Paper.	C40	.1 mfd.	Tub. Paper.
C12	20 pf.	Ceramic.	C41	100 pf.	Silvered Mica.
C13	3—20 pf.	Air Trimmer.	C42	100 pf.	Silvered Mica.
C14	6 pf.	Ceramic.	C43	2 pf.	Ceramic.
C15	3—20 pf.	Air Trimmer.	C44	100 pf.	Ceramic.
C16	3—20 pf.	Air Trimmer.	C45	.1 mfd.	Tub. Paper.
C17	3—20 pf.	Air Trimmer.	C46	100 pf.	Ceramic.
C18	.1 mfd.	Tub. Paper.	C47	.01 mfd.	Tub. Paper.
C19	100 pf.	Silvered Mica.	C48	25 mfd.	25 V. Tub. Elect.
C20	11.5—210.6 mmfd.	Mixer Sect. 3 Gang.	C49	8 mfd.	Tub. Elect.
C21	.1 mfd.	Tub. Paper.	C50	20 pf.	Ceramic.
C22	.01 mfd.	Tub. Paper.	C51	.0005 mfd.	Moulded Mica.
C23	100 pf.	Silvered Mica.	C52	.01 mfd.	Moulded Mica.
C24	.1 mfd.	Tub. Paper.	C53	25 mfd.	25 V. Tub. Elect.
C25	100 pf.	Silvered Mica.	C54	.05 mfd.	Tub. Paper.
C26	.1 mfd.	Tub. Paper.	C55	.01 mfd.	Tub. Paper.
C27	100 pf.	Silvered Mica.	C56	.0005 mfd.	Moulded Mica.
C28	.01 mfd.	Tub. Paper.	C57	.01 mfd.	Tub. Paper.
C29	3.5—20 pf.	Ceramic Trimmer.	C58	12 mfd.	Tub. Elect.
			C59	16 mfd.	Tub. Elect.

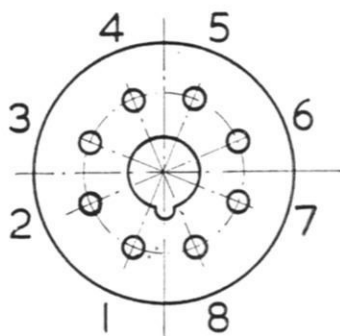
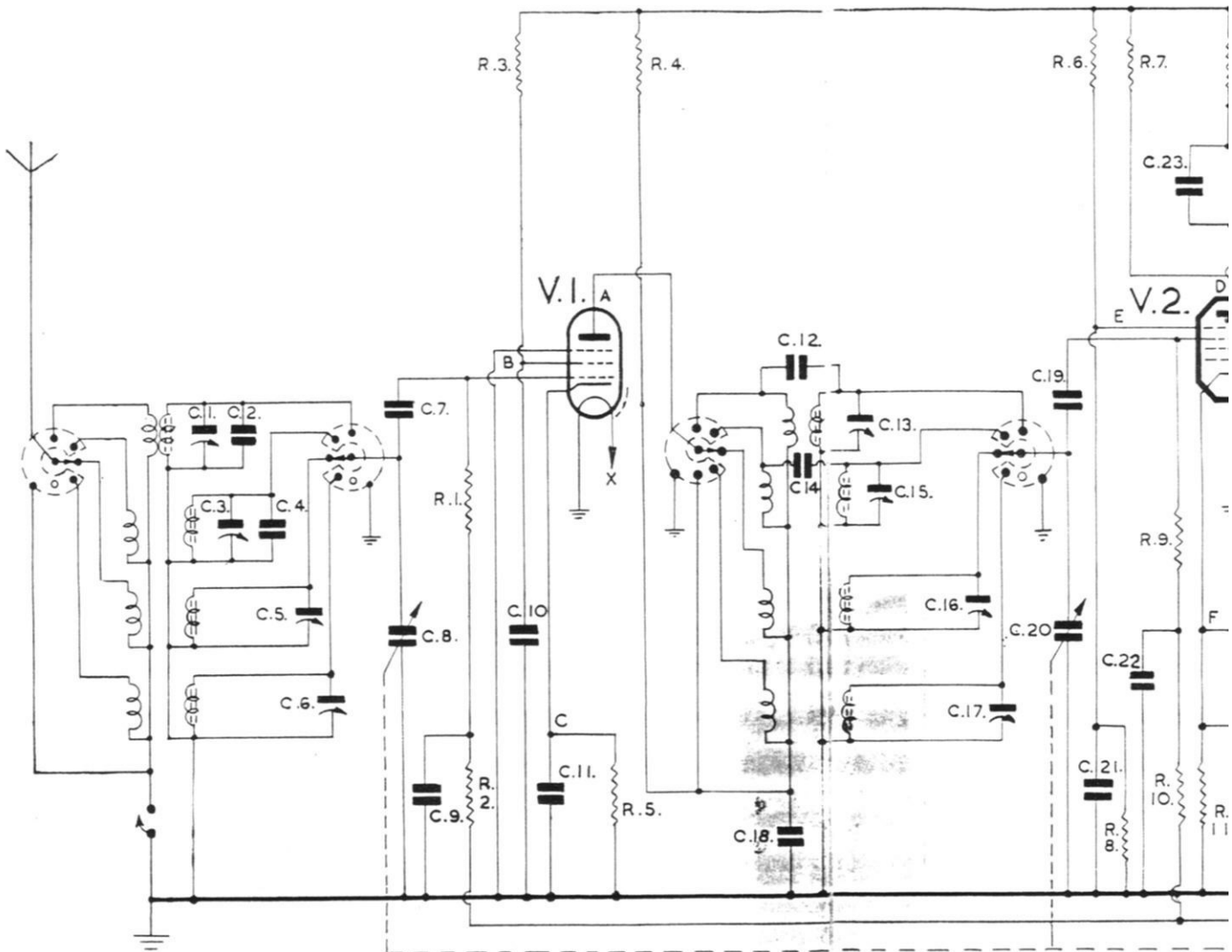

VALVE.	1	2	3	4	5	6	7	8	TOP CAP.
EF. 39.	M	H	A	G2	G3	-	H	K	G1
EBC. 33.	M	H	A	D1	D2	-	H	K	G1
EM. 34.	-	H	A	I	G	S	A2	H	K
EB. 34.	M	H	D1	K1	D	-	H	K	-
6K8GT.	-	H	A	G2	G1	A	H	K	G3
6V6GT.	-	H	A	G2	G1	-	H	K	-
6X5GT.	-	H	A	-	A	-	H	K	-

